

GEORGE FOREMAN®

HEALTHY COOKING

George Foreman



HEALTH JUICER

Instructions & Warranty

GFJE2200AU

Spectrum Brands Australia Pty Ltd
Locked Bag 3004 Braeside
Victoria 3195 Australia
Customer Service in Australia
TollFree: 1800 623 118
Email: info@spectrumbrands.com.au
Website: www.spectrumbrands.com.au

Spectrum Brands New Zealand Ltd
PO Box 9817 Newmarket
Auckland 1149 New Zealand
Customer Service in New Zealand
TollFree: 0800 736 776
Email: service@spectrumbrands.co.nz
Website: www.spectrumbrands.co.nz

Spectrum Brands Australia Pty Ltd and Spectrum Brands New Zealand Ltd Warranty Against Defects

In this warranty:

Australian Consumer Law means the Australian consumer law set out in Schedule 2 to the Competition and Consumer Act 2010;

CGA means the New Zealand Consumer Guarantees Act 1993;

Goods means the product or equipment which was accompanied by this warranty and purchased in Australia or New Zealand, as the case may be;

Manufacturer, We or us means:

1. for Goods purchased in Australia, Spectrum Brands Australia Pty Ltd ABN, 78 007 070 573;
or
2. for Goods purchased in New Zealand, Spectrum Brands New Zealand Ltd, as the case may be, contact details as set out at the end of this warranty;

Supplier means the authorised distributor or retailer of the Goods that sold you the Goods in Australia or in New Zealand; and

You means you, the original end-user purchaser of the Goods.

1. Our goods come with guarantees that cannot be excluded under the Australian Consumer Law, or the CGA. You are entitled to a replacement or refund for a major failure and compensation for any other reasonably foreseeable loss or damage. You are also entitled to have the goods repaired or replaced if the goods fail to be of acceptable quality and the failure does not amount to a major failure.
2. The benefits provided by this Warranty are in addition to all other rights and remedies in respect of the Goods which the consumer has under either the Australian Consumer Law or the CGA. The original purchaser of the Goods is provided with the following Warranty subject to the Warranty Conditions:
3. We warrant the Goods for all parts defective in workmanship or materials from the date of purchase (Warranty Period), for the period of:-
 - (a) Two (2) years for Russell Hobbs products (see product packaging for details)
 - (b) Two (2) years with five (5) year motor warranty for Russell Hobbs products (see product packaging for details)
 - (c) Limited Lifetime, Ten (10) years for Russell Hobbs cookware.
 - (d) One (1) year for George Foreman, iRobot, Westinghouse, Black & Decker and Spectrum Brands products.

If the Goods prove defective within the Warranty Period by reason of improper workmanship or material, we may, at our own discretion, repair or replace the Goods without charge.

Warranty Conditions

4. The Goods must be used in accordance with the manufacturer's instructions. This Warranty does not apply should the defect in or failure of the Goods be attributable to misuse, abuse, accident or non-observance of manufacturer's instructions on the part of the user. As far as the law permits, the manufacturer does not accept liability for any direct or consequential loss, damage or other expense caused by or arising out of any failure to use the Goods in accordance with the manufacturer's instructions.
5. Exhaustible components (such as batteries, filters and brushes) of the Goods are included under this Warranty only where there is a defect in workmanship or materials used.
6. The warranty granted under clause 3 is limited to repair or replacement only.
7. Any parts of the Goods replaced during repairs or any product replaced remain the property of the manufacturer. In the event of the Goods being replaced during the Warranty Period, the warranty on the replacement Goods will expire on the same date as for the Warranty Period on the original Goods which are replaced.
8. In order to claim under the warranty granted under clause 3 you must:
 - (a) Retain this warranty with your receipt/proof of purchase; and
 - (b) Return the Goods to us at the relevant address or to the Supplier by prepaid freight within the Warranty Period accompanied with (i) the legible and unmodified original proof of purchase, which clearly indicates the name and address of the Supplier, the date and place of purchase, the product name or other product serial number and (ii) this warranty.
9. This warranty is immediately void if:
 - (a) Any serial number or appliance plate is removed or defaced;
 - (b) The Goods have been serviced or otherwise repaired by a person not authorised to do so by us or where non approved replaced parts are used.
10. The Goods are designed for domestic use only. A limited 90-day Warranty applies to any industrial or commercial use of the Goods. The Goods must be connected to the electrical voltage requirements as specified in the ratings label located on the Goods.
11. This warranty does not cover the cost of claiming under the warranty or transport of the Goods to and from the Supplier or us.
12. This warranty is only valid and enforceable in Australia against Spectrum Brands Australia Pty Ltd and in New Zealand against Spectrum Brands New Zealand Ltd.

Contact us or the Supplier for further details.

Register your product online

If you live in Australia please visit: www.spectrumbrands.com.au/warranty

If you live in New Zealand Please visit: www.spectrumbrands.co.nz/warranty

Registration of your warranty is not compulsory, it gives us a record of your purchase AND entitles you to receive these benefits: Product information; Hints and tips; Recipes and news; Information on special price offers and promotions.

Any questions? Please contact Customer Service for advice.

Congratulations on the purchase of your George Foreman Juicer. Each unit is manufactured to ensure safety and reliability. Before using the appliance for the first time, please read the instruction book carefully and keep it for future reference. Pass it on if you pass on the appliance.

When using electrical appliances, basic safety precautions should always be followed.

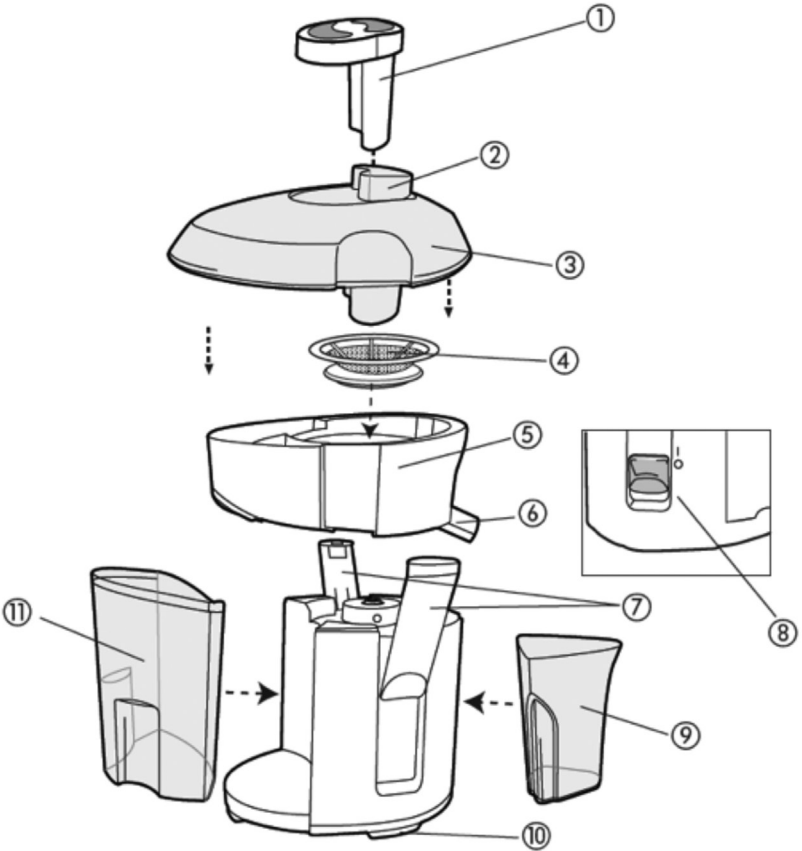

- | | |
|------------------------------------|--|
| 1. Fruit and vegetable feeder | 7. Safety locking latch (on each side) |
| 2. Food chute | 8. On/off (I/O) control |
| 3. Clear cover | 9. Juice container |
| 4. Stainless steel cutter/strainer | 10. Non-slip rubber feet |
| 5. Pulp separator | 11. Removable pulp container |
| 6. Continuous flow juice spout | |

HOW TO USE

Remove all labels, tags and stickers attached to the body or cord.

Important: Before you use it for the first time, disassemble the unit (see HOW TO DISASSEMBLE section); wash all parts as instructed in the CARE AND CLEANING section.

HOW TO ASSEMBLE AND USE

1. Place the pulp separator on the base with the juice spout facing you.
2. Insert the cutter/strainer in the centre of the pulp separator. Press it down until it snaps into place.
3. Grip the pulp container and slide it in until it snaps into place.

Important: Do not operate juice extractor without pulp container in place.

4. Place the cover on top of the pulp separator with feeder in place.
5. Lock the locking latches by pressing down the cover as you fit the tab at the top of each latch into the groove on each side of the cover. Press the bottom of each latch until you hear it click into place.

Important: The unit will not operate until the locking latches are locked.

6. Place the juice cup under the juice spout.
7. Cut food into pieces to fit the food chute.
8. Plug unit into electrical outlet. Press the on/off (I/O) switch to the on position.
9. Place food in the food chute and press lightly with the feeder.
10. Every time the pulp container is almost full, turn the unit off (0) and unplug from outlet, empty the pulp container and clean the cutter/strainer before you start juicing again.

Caution: The cutter/strainer teeth are very sharp. Handle carefully.

11. When juicing is completed, turn the unit off (0) and unplug from outlet.

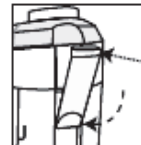
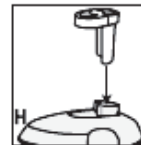
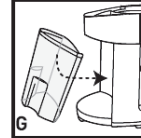
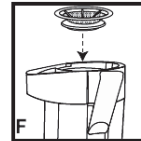
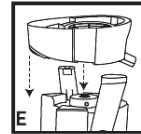

HOW TO DISASSEMBLE

1. To unlock the locking latches, pull open at the bottom of each latch to disengage from the groove on the cover.
2. To remove the cover, take out the feeder, grasp the chute and pull up the cover.
3. To remove the pulp separator, grip the juice spout with one hand and the back edge of the pulp separator with the other hand. Pull it up with the cutter/strainer in place.
4. To remove the cutter/strainer, hold the juice spout with one hand and grasp the cutter/strainer rim with the other hand; pull it out.

Caution: The cutter/strainer teeth are very sharp. Handle it carefully.

5. To remove the pulp container, grasp the sides firmly and slide it out.

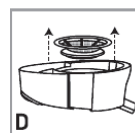
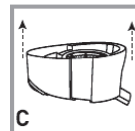
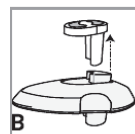
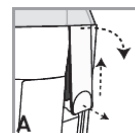

CARE AND CLEANING

TO CLEAN THE UNIT

Caution: To prevent possible damage to the appliance do not use harsh abrasive or alkaline cleaning agents.

Always clean all parts after every use to prolong the life of the unit.

- Turn unit off (0) and unplug from electric outlet.
- Disassemble all parts. See HOW TO DISASSEMBLE section.
- Wash the feeder, food chute, cover, cutter/strainer, pulp separator, juice spout, juice cup and pulp container in warm soapy water

Caution: The cutter/strainer teeth are very sharp. Handle carefully.

- Wipe the base with a damp cloth or sponge. Never immerse the unit in water.

Note: Over time, parts may change colour (especially from juicing carrots or beetroots).

JUICING TIPS

- When juicing carrots, do not overfill the food chute. Place carrots one by one and use gentle pressure.
- Juicing avocados or bananas will produce a puree rather than a juice.
- When juicing large quantities of fruits and vegetables, stop and empty the pulp container as it begins to get full and clean the cutter/strainer before you start juicing again.

IMPORTANT SAFEGUARDS

1. To protect against electric shock do not immerse cord, plug or body of unit in water or liquid of any sort.
2. Do not use outdoors or in damp or moist areas.
3. This appliance is not intended for use by persons (including children) with reduced physical, sensory or mental capabilities, or lack of experience and knowledge, unless they have been given supervision or instruction concerning use of the appliance by a person responsible for their safety.
4. This appliance is NOT a toy. Young children should be supervised to ensure they do
5. NOT play with the appliance.
6. Always turn off and unplug from the wall power outlet when not in use, before fitting or removing parts, and before cleaning the appliance.
7. To disconnect, ensure the appliance switch is set to off, turn off the wall power outlet, then grasp and pull the plug from the wall outlet. Never pull by the cord.
8. Do not operate this appliance with a damaged cord/plug or after the appliance has been dropped, damaged or has malfunctioned in any manner. Contact customer service for replacement, examination, repair or adjustment.
9. There are no user serviceable parts. If the power cord or appliance is damaged, it must be repaired or replaced by the manufacturer or a suitably qualified person in order to avoid hazard.
10. The use of attachments/ accessories not recommended by the appliance manufacturer may cause injuries or damage to the appliance.
11. Do not use on an inclined plane or unstable surface.
12. Keep the appliance and the power cord away from the edge of tables or countertops and out of reach of children and infirm persons.
13. Keep hands and utensils away from moving cutter/strainer disc while juicing/grinding foods to prevent the possibility of severe personal injury or damage to the appliance.

14. Care must be taken when handling any accessories with sharp edges.
15. NEVER place hands or utensils into the juicer opening or near any moving parts while the appliance is operating.
16. Do not attempt to defeat any safety interlock mechanisms.
17. Do not use the appliance if the cutter/strainer is damaged.
18. Do not unclamp the safety locking latches during operation.
19. Always clean the appliance after use.
20. Follow the instructions when cleaning this appliance.
21. Do not place on or near any heat sources.
22. Do not leave the appliance unattended when in use.
23. Do not use appliance for other than its intended purpose.
24. This appliance is not a toy. Children should be supervised to ensure they do not play with the appliance.
25. This appliance is not intended to be operated by means of an external timer or separate remote control system.
26. For added safety, electrical appliances should be connected to a power outlet that is protected by a residual current device (RCD), also often referred to as a 'Safety Switch'. Your switchboard may already incorporate an RCD. If unsure, call an electrician for verification and fitting if necessary.
27. To prevent possible damage to the appliance do not use harsh abrasive or alkaline cleaning agents.

SAVE THESE INSTRUCTIONS

THIS APPLIANCE IS FOR HOUSEHOLD USE ONLY

GEORGE FOREMAN®

HEALTHY COOKING



www.georgeforeman.com.au

www.georgeforeman.co.nz

GEORGE FOREMAN and logo are trade marks of Spectrum Brands, Inc., or one of its subsidiaries.

©2012 Spectrum Brands, Inc.